

IASO®

Better Outside

CATALOGUE
CATALOGUE

ENGLISH
FRANÇAIS

PARASOLS
PARASOLS

SMALL COLLECTION
2026

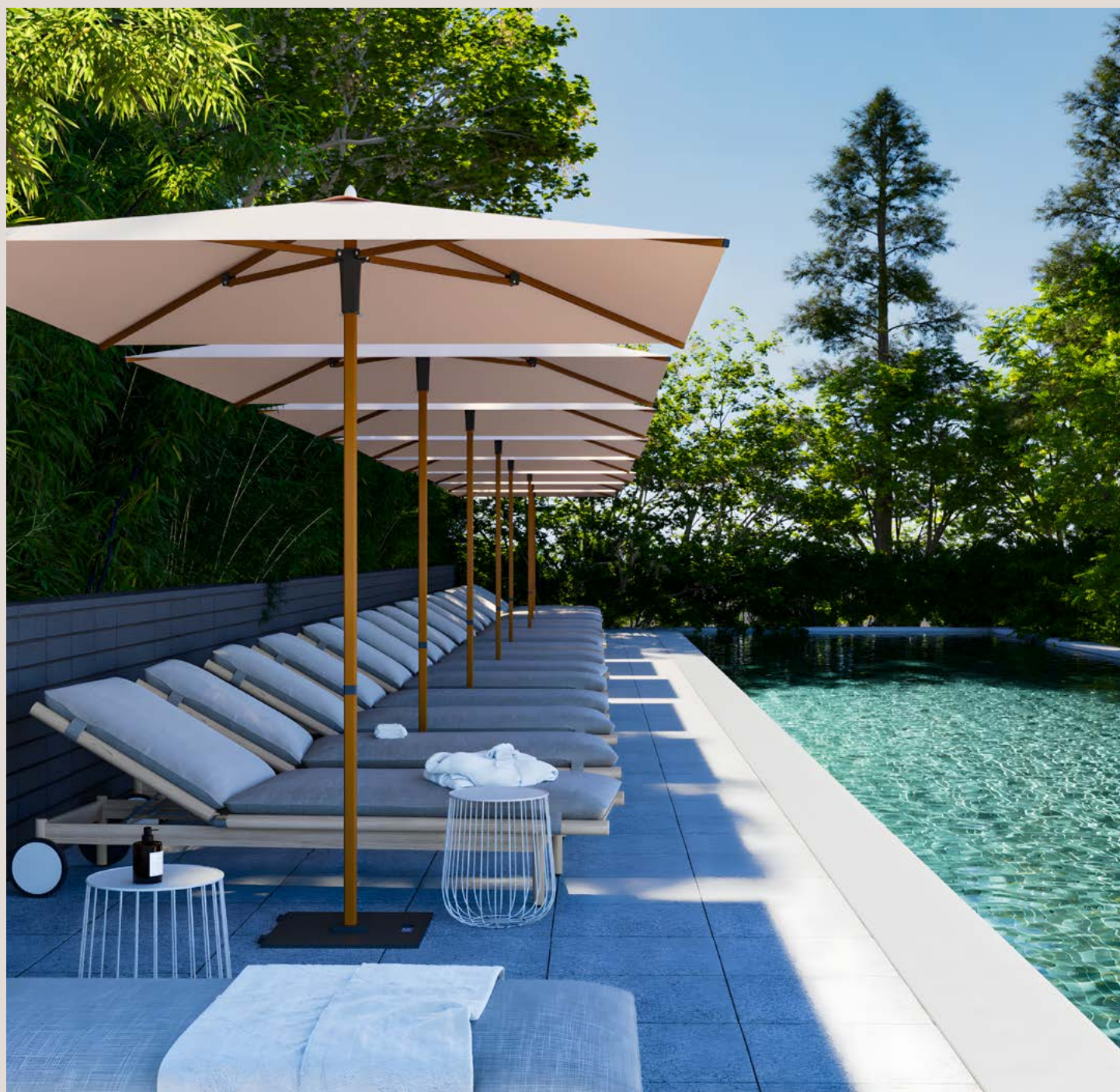

We bring people together.

Pioneering shades as spaces meant to be lived.

Spaces to breathe, rest, connect, and celebrate.

Our products are made for a joyful living.

Every step is guided by a pursuit of excellence and
exceptional attention to detail is at the heart of everything we do.

We transform open spaces into places where life happens,
spaces where people build their memories, where stories are born.

Because we believe life is

Better Outside

FOUR DECADES OF EXCELLENCE

40 years of outstanding
sun shading



En 1984, nous avons entamé un voyage dans l'univers de la protection solaire. Stores, parasols et pergolas ont marqué nos débuts, nous établissant rapidement comme l'une des marques les plus emblématiques de la péninsule ibérique.

Au fil des années, notre vision nous a conduits à nous spécialiser dans les solutions textiles pour les espaces extérieurs, en élargissant nos activités aux Piscines et à l'Architecture Textile. Cette orientation nous a permis de franchir les frontières, en portant nos créations dans plus de 36 pays.

En 2024, nous célébrons 40 ans à transformer les espaces extérieurs en lieux où les histoires prennent vie, en nous réaffirmant comme une référence internationale en matière de protection solaire textile.



In 1984, we began a journey in the world of sun shading. Awnings, parasols, and pergolas marked our beginnings, quickly establishing us as one of the most iconic brands in the Iberian Peninsula.

Over the years, our vision led us to specialize in outdoor textile solutions, expanding our focus to Pools and Textile Architecture. This direction allowed us to cross borders, bringing our creations to over 36 countries.

In 2024, we celebrate 40 years of transforming outdoor spaces into settings where stories come to life, reaffirming our position as international leaders in textile solar shading.

QUATRE
DÉCENNIES
D'EXCELLENCE

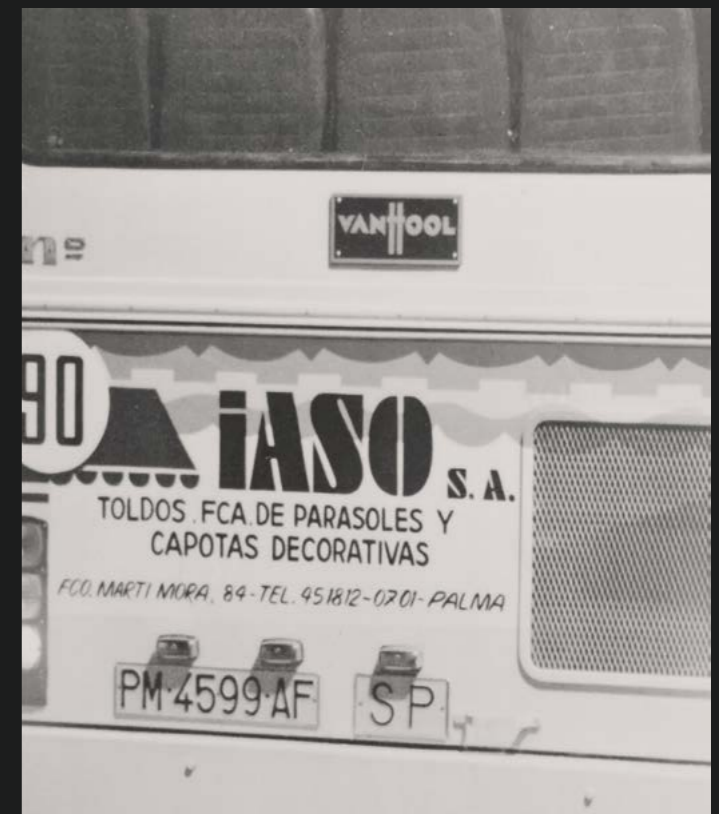

OUR IDENTITY

At IASO, evolving means paying attention to every detail, transcending functionality to create experiences that inspire. Today, guided by our core values, we continue to look to the future with an unwavering commitment to innovate and connect.

ELEGANCE AND ENGINEERING

At IASO, engineering becomes art. Each design is crafted to find the perfect balance between flawless functionality and inspiring aesthetics. With clean lines and precise details, our solutions transcend time, creating spaces that are as impactful as they are practical.

QUALITY AND INNOVATION

For us, excellence is not a destination but a constant journey. From our R&D team, we envision new ways to bring products to life that combine technical efficiency with visionary solutions.

HUMAN CONNECTION

We believe in the power of spaces to bring people together. Each of our projects is designed to evoke emotions, inviting the sharing of unique moments. Our commitment starts with the first contact and extends well beyond, supporting our clients at every stage with a close and thoughtful approach.



NOTRE IDENTITÉ

Chez IASO, évoluer signifie prendre soin de chaque détail, en allant au-delà de la simple fonctionnalité pour créer des expériences qui inspirent. Aujourd'hui, guidés par nos valeurs fondamentales, nous continuons de regarder vers l'avenir avec un engagement inébranlable envers l'innovation et la connexion.

ÉLÉGANCE ET INGÉNIERIE

Chez IASO, l'ingénierie devient un art. Chaque design est conçu pour atteindre l'harmonie parfaite entre une fonctionnalité irréprochable et une esthétique inspirante. Avec des lignes épurées et des détails soignés, nos solutions traversent le temps, créant des espaces aussi impressionnants qu'utiles.

QUALITÉ ET INNOVATION

Pour nous, l'excellence n'est pas une destination, mais un chemin en constante évolution. Grâce à notre équipe de R+D+, nous imaginons de nouvelles façons de donner vie à des produits qui combinent efficacité technique et solutions visionnaires.

CONNEXION HUMAINE

Nous croyons au pouvoir des espaces pour rassembler les personnes. Chacun de nos projets est conçu pour susciter des émotions et inviter à partager des moments uniques. Notre engagement commence dès le premier contact et se poursuit bien au-delà, en accompagnant nos clients à chaque étape avec une approche attentive et chaleureuse.

SMALL COLLECTION	—	11
		15
		19
		23
		27
		31
		34
		37
		41
		45
		48

SMALL COLLECTION

Small Collection is designed for compact spaces, such as patios and small terraces. These parasols provide effective sun shading with versatile and lightweight designs, ideal for gardens and businesses looking for practical, light, and accessible solutions.

Small Collection est conçue pour les espaces réduits, tels que les patios et les petites terrasses. Ces parasols offrent une protection solaire efficace avec des designs polyvalents et légers, parfaits pour les jardins et les établissements recherchant des solutions pratiques, légères et accessibles.





Elegant
lighting
for every
moment

*Éclairage
élégant pour
chaque
instant*

CALPE

CONFIGURATION

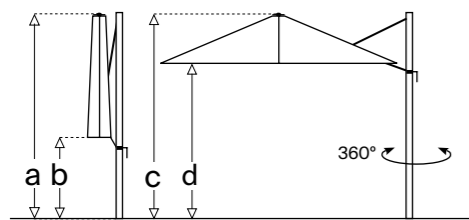

*Offset mast
*Mât excentré

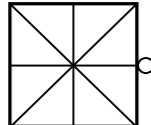
Model Modèle	Measurements Mesures	No. Ribs N° Baleines	Mole* Mât*	a	b	c	d
	3 x 3 m	8	75 x 100 cm	252 cm	50 cm	255 cm	215 cm

DETAILS DÉTAILS

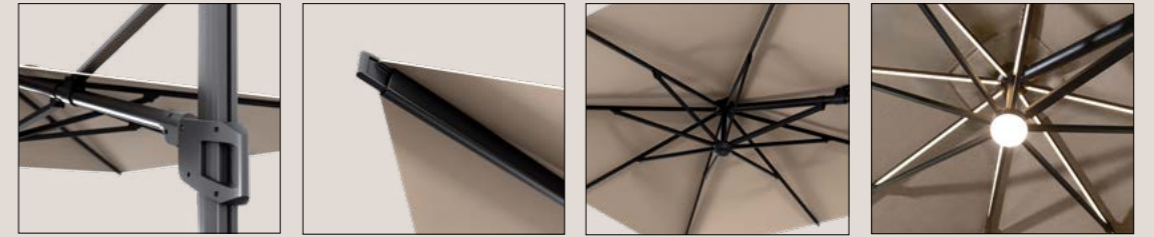

FUNCTION FONCTION

- Left and right tilting
Basculement gauche et droite
- Up and down inclination
Inclinaison vers le haut et le bas
- 360° rotation
Rotation à 360°

MAST COLOUR COULEUR DU MÂT

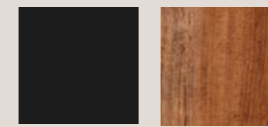

Black
Noir

Wood
finish
Effet bois

FABRIC COLOUR COULEUR DE TISSU



Beige
olefin
Oléfine
beige

Terracotta
olefin
Oléfine
terracotta

Dark green
olefin
Oléfine
vert
foncé

INCLUDED ACCESSORIES ACCESSOIRES INCLUS



LED lights
with solar panel
Lumières LED
avec panneau solaire



Cross base
Base en croix

COMPATIBILITY COMPATIBILITÉ

Check base compatibility (p. 52)
Consulter la compatibilité des bases (p. 52)

Check cover compatibility (p. 54)
Consulter la compatibilité des housses (p. 54)

APPLICATIONS APPLICATIONS



Private
Particulier

Hotel
Hôtel

Resort
Resort

Restaurant
Restaurant

Bar
Bar

Café
Café



Practical
design
and total
precision

*Design
pratique et
précision
totale*

PISA

CONFIGURATION

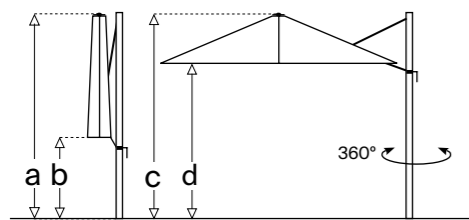

*Offset mast
*Mât excentré

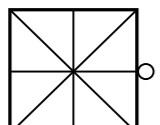
Model Modèle	Measurements Mesures	No. Ribs N° Baleines	Mole* Mât*	a	b	c	d
	3 x 3 m	8	65 x 95 cm	270 cm	50 cm	270 cm	210 cm

DETAILS DÉTAILS

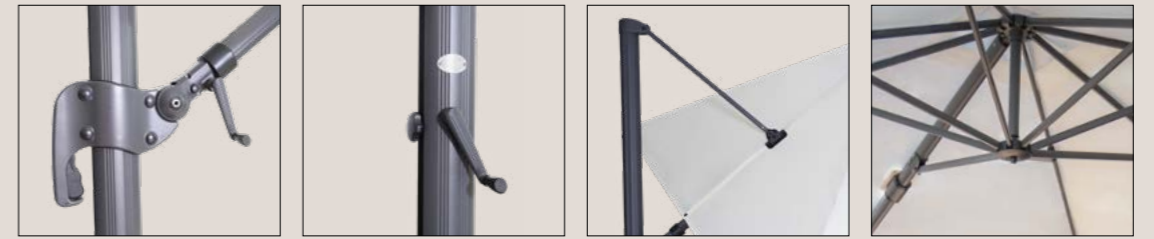

FUNCTION FONCTION

- Left and right tilting
Basculement gauche et droite
- Up and down inclination
Inclinaison vers le haut et le bas
- 360° rotation
Rotation à 360°

MAST COLOUR COULEUR DU MÂT



Anthracite
Anthracite

FABRIC COLOUR COULEUR DE TISSU

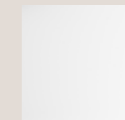

White polyester
Polyester blanc

INCLUDED ACCESSORIES ACCESSOIRES INCLUS



Cross base
Base en croix

COMPATIBILITY COMPATIBILITÉ

Check base compatibility (p. 52)
Consulter la compatibilité des bases (p. 52)

Check cover compatibility (p. 54)
Consulter la compatibilité des housses (p. 54)

APPLICATIONS APPLICATIONS



Private
Particulier



Hotel
Hôtel



Resort
Resort



Restaurant
Restaurant



Bar
Bar



Café
Café



Sophisticated
lighting and
complete
protection

*Éclairage
sophistiqué
et protection
complète*

SINTRA

CONFIGURATION

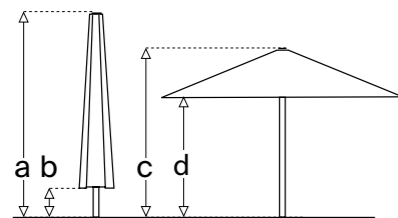

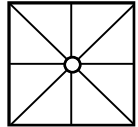
Model Modèle	Measurements Mesures	No. Ribs N° Baleines	Mole Mât	a	b	c	d
	4 x 4 m	8	Ø60 mm	362 cm	65 cm	239 cm	225 cm

DETAILS DÉTAILS

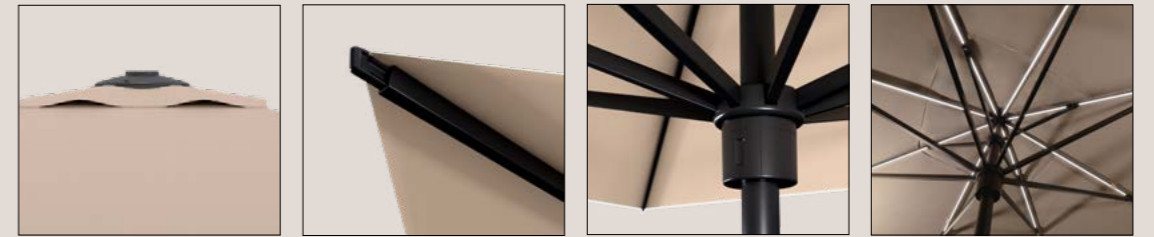

MAST COLOUR COULEUR DU MÂT

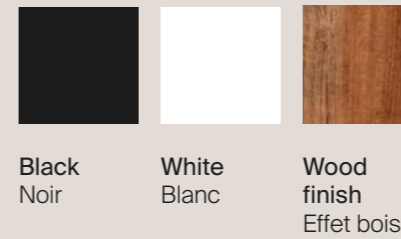

FABRIC COLOUR COULEUR DE TISSU



INCLUDED ACCESSORIES ACCESSOIRES INCLUS



LED lights
with solar panel
Lumières LED
avec panneau solaire



Cross base
Base en croix

COMPATIBILITY COMPATIBILITÉ

Check base compatibility (p. 52)
Consulter la compatibilité des bases (p. 52)

Check cover compatibility (p. 54)
Consulter la compatibilité des housses (p. 54)

APPLICATIONS APPLICATIONS



Private
Particulier

Hotel
Hôtel

Resort
Resort

Restaurant
Restaurant

Bar
Bar

Café
Café



Elegance,
versatility,
and durability

*Élégance,
polyvalence
et résistance*

ARLES

CONFIGURATION

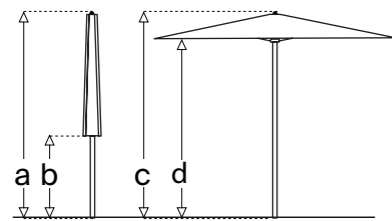

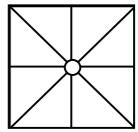
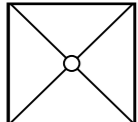
Model Modèle	Measurements Mesures	No. Ribs N° Baleines	Mole Mât	a	b	c	d
	3 x 3 m	8	Ø48 mm	263 cm	55 cm	263 cm	220 cm
Model Modèle	Measurements Mesures	No. Ribs N° Baleines	Mole Mât	a	b	c	d
	2,5 x 2,5 m	4	Ø48 mm	263 cm	80 cm	263 cm	220 cm

DETAILS DÉTAILS

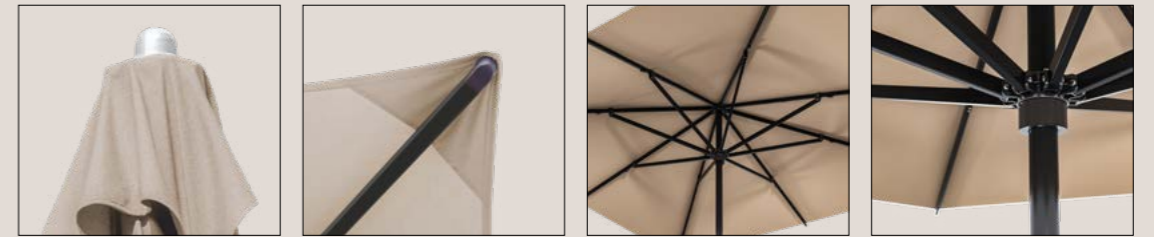

MAST COLOUR COULEUR DU MÂT

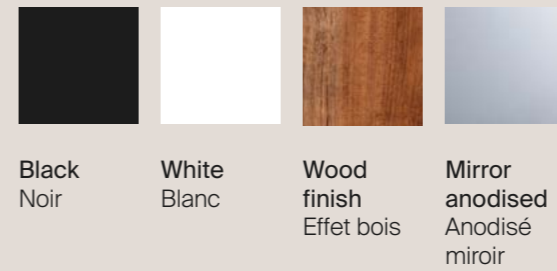

Black
Noir

White
Blanc

Wood
finish
Effet bois

Mirror
anodised
Anodisé
miroir

FABRIC COLOUR COULEUR DE TISSU



Beige
olefin
Oléfine
beige

Terracotta
olefin
Oléfine
terracotta

Dark green
olefin
Oléfine
vert
foncé

COMPATIBILITY COMPATIBILITÉ

UFO LIGHT (p. 50)
UFO LIGHT (p. 50)

Check base compatibility (p. 52)
Consulter la compatibilité des bases (p. 52)

Check cover compatibility (p. 54)
Consulter la compatibilité des housses (p. 54)

APPLICATIONS APPLICATIONS



Private
Particulier

Hotel
Hôtel

Resort
Resort

Restaurant
Restaurant

Bar
Bar

Café
Café

Compact
and
functional

*Design
compact et
fonctionnel*

ANTIBES



CONFIGURATION

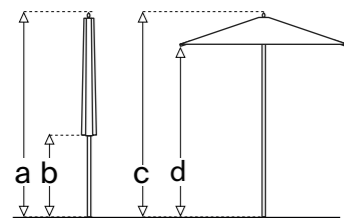

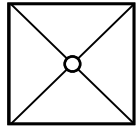
Model Modèle	Measurements Mesures	No. Ribs N° Baleines	Mole Mât	a	b	c	d
	2,2 x 2,2 m	4	38 x 38 mm	235 cm	80 cm	235 cm	195 cm

DETAILS DÉTAILS

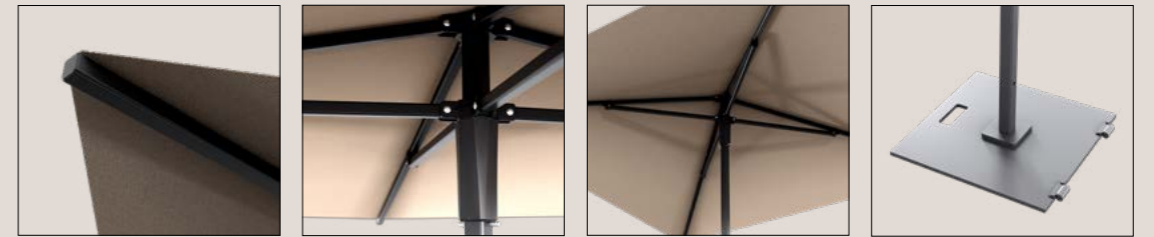

MAST COLOUR COULEUR DU MÂT

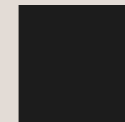

Black
Noir



White
Blanc

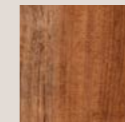

Wood Finish
Effet Bois

FABRIC COLOUR COULEUR DE TISSU



Beige olefin
Oléfine beige

INCLUDED ACCESSORIES ACCESSOIRES INCLUS

Antibes Base (p. 46)
Base Antibes (p. 46)

COMPATIBILITY COMPATIBILITÉ

UFO LIGHT (p. 50)
UFO LIGHT (p. 50)

Check base compatibility (p. 52)
Consulter la compatibilité des bases (p. 52)

Check cover compatibility (p. 54)
Consulter la compatibilité des housses (p. 54)

APPLICATIONS APPLICATIONS



Private
Particulier



Hotel
Hotel



Resort
Resort

Lightness
and
practicality
for exclusive
spaces

*Légèreté et
praticité pour
des espaces
exclusifs*

TAVIRA



CONFIGURATION

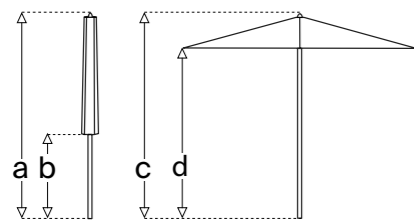

Model Modèle	Measurements Mesures	No. Ribs N° Baleines	Mole Mât	a	b	c	d
	Ø2,5 m	6	Ø38,4 mm	233 cm	100 cm	233 cm	195 cm

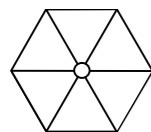

DETAILS DÉTAILS

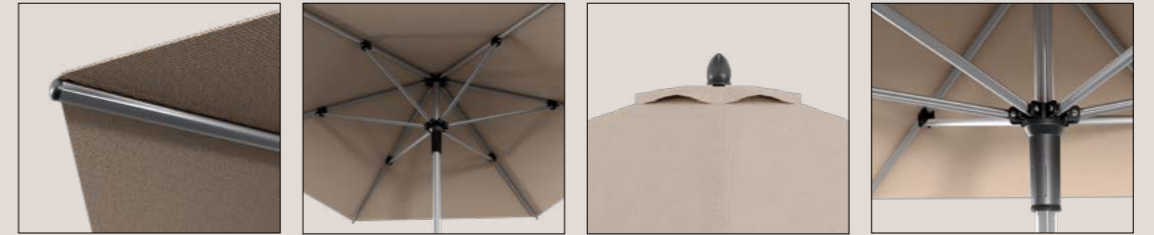

MAST COLOUR COULEUR DU MÂT

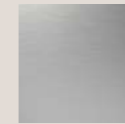

Matte anodised
Anodisé mat

FABRIC COLOUR COULEUR DE TISSU



Beige olefin
Oléfine beige

COMPATIBILITY COMPATIBILITÉ

UFO LIGHT (p. 50)
UFO LIGHT (p. 50)

Check base compatibility (p. 52)
Consulter la compatibilité des bases (p. 52)

Check cover compatibility (p. 54)
Consulter la compatibilité des housses (p. 54)

APPLICATIONS APPLICATIONS



Private
Particulier



Hotel
Hôtel



Resort
Resort

ADVERTISING LINE

LIGNE PUBLICITAIRE

Customised Parasols

Designed to provide sun shading and brand visibility in outdoor spaces, our parasols combine durability, design, and complete customisation. Available in various sizes and finishes, they are perfect for branded terraces, outdoor events, and promotional fairs.

Parasols Personnalisés

Conçus pour offrir une protection solaire et une visibilité optimale en extérieur, nos parasols allient résistance, design et personnalisation totale. Disponibles dans une large gamme de tailles et de finitions, ils sont parfaits pour les terrasses de marque, les événements en plein air et les salons promotionnels.





Simplicity,
comfort, and
ergonomics

*Simplicité,
confort et
ergonomie*

RAYDEN

CONFIGURATION

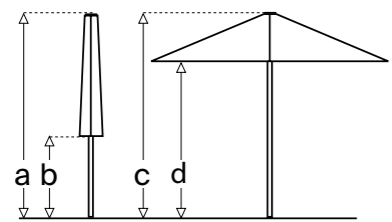

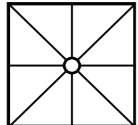
Model Modèle	Measurements Mesures	No. Ribs N° Baleines	Mast Mât	a	b	c	d
	3 x 3 m	8	Ø50 mm	274 cm	70 cm	274 cm	220 cm

DETAILS DÉTAILS

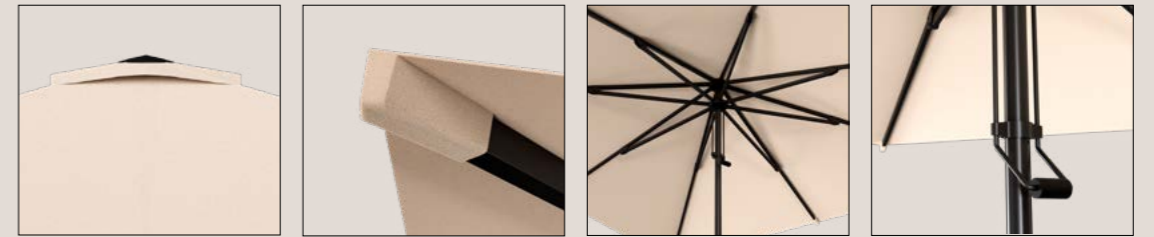

MAST COLOUR COULEUR DU MÂT



Anthracite
Anthracite

FABRIC COLOUR COULEUR DE TISSU

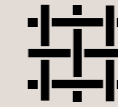

Fully customisable. Discover our full range of colours with our experts.
Entièrement personnalisable. Découvrez toute notre gamme de couleurs avec nos experts.

COMPATIBILITY COMPATIBILITÉ

Check base compatibility (p. 52)
Consulter la compatibilité des bases (p. 52)

Check cover compatibility (p. 54)
Consulter la compatibilité des housses (p. 54)

CUSTOMISATION PERSONNALISATION

Rayden allows for a fully customised fabric setup to adapt your brand and corporate image 100% through various signage solutions.
Rayden permet une configuration personnalisée de la toile pour adapter votre marque et votre image d'entreprise à 100 % grâce à différentes solutions de marquage.

APPLICATIONS APPLICATIONS



Hotel
Hôtel

Restaurant
Restaurant

Bar
Bar

Café
Café



Strength,
robustness,
and versatility

*Résistance,
robustesse et
polyvalence*

STAR ONE

CONFIGURATION

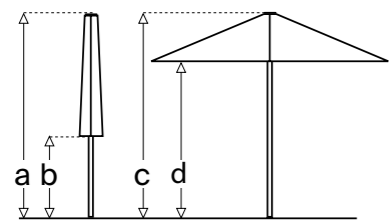

Model Modèle	Measurements Mesures	No. Ribs N° Baleines	Mole Mât	a	b	c	d
	2,5 x 2,5 m	4	Ø50 mm	260 cm	130 cm	260 cm	226 cm
	2 x 2 m	4	Ø50 mm	260 cm	78 cm	260 cm	226 cm

DETAILS DÉTAILS

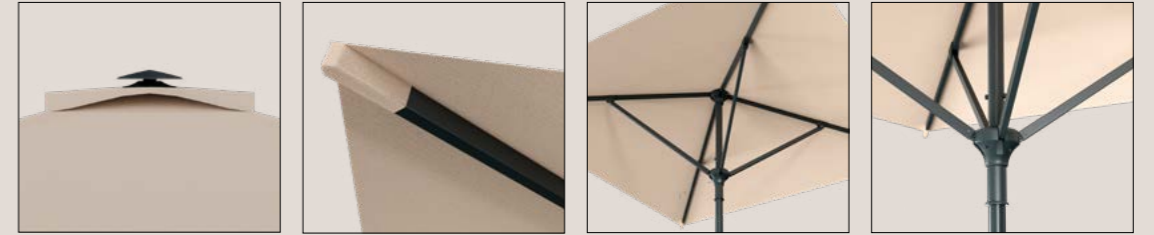

MAST COLOUR COULEUR DU MÂT



RAL 7026

FABRIC COLOUR COULEUR DE TISSU



Fully customisable. Discover our full range of colours with our experts.
Entièrement personnalisable. Découvrez toute notre gamme de couleurs avec nos experts.

COMPATIBILITY COMPATIBILITÉ

Check base compatibility (p. 52)
Consulter la compatibilité des bases (p. 52)

Check cover compatibility (p. 54)
Consulter la compatibilité des housses (p. 54)

CUSTOMISATION PERSONNALISATION

Star One allows for a fully customised fabric setup (polyester and acrylic) to adapt your brand and corporate image 100% through various signage solutions.
Star One permet une configuration personnalisée de la toile (polyester et acrylique) pour adapter votre marque et votre image d'entreprise à 100 % grâce à différentes solutions de marquage.

APPLICATIONS APPLICATIONS



Hotel
Hotel



Restaurante
Restaurante



Bar
Bar



Cafeteria
Cafeteria



Minimalism
and stylish
protection

*Minimalisme
et protection
avec style*

STAR LIT

CONFIGURATION

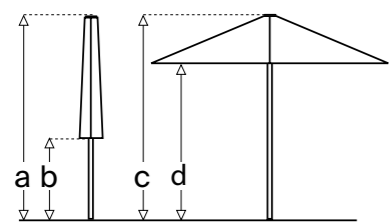

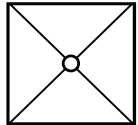
Model Modèle	Measurements Mesures	No. Ribs N° Baleines	Mole Mât	a	b	c	d
	2,5 x 2,5 m	4	Ø38 mm	258 cm	82 cm	258 cm	220 cm
	2 x 2 m	4	Ø38 mm	258 cm	113 cm	258 cm	220 cm

DETAILS DÉTAILS

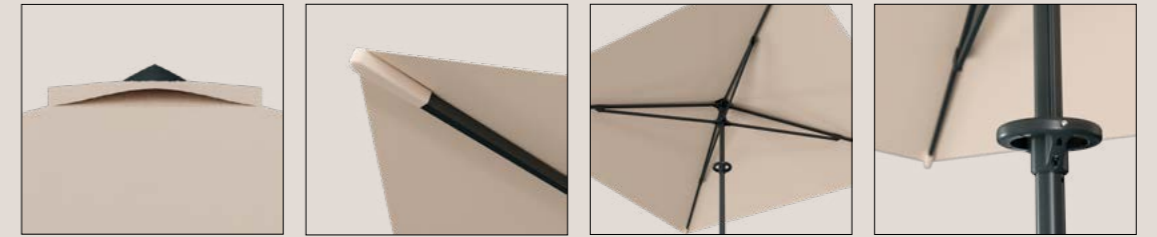

MAST COLOUR COULEUR DU MÂT



RAL 7026

FABRIC COLOUR COULEUR DE TISSU



Fully customisable. Discover our full range of colours with our experts.
Entièrement personnalisable. Découvrez toute notre gamme de couleurs avec nos experts.

COMPATIBILIDAD COMPATIBILIDADE

UFO LIGHT (p. 50)
UFO LIGHT (p. 50)

Check base compatibility (p. 52)
Consulter la compatibilité des bases (p. 52)

Check cover compatibility (p. 54)
Consulter la compatibilité des housses (p. 54)

CUSTOMISATION PERSONNALISATION

Star Lit allows for a fully customised fabric setup (polyester and acrylic) to adapt your brand and corporate image 100% through various signage solutions.

Star Lit permet une configuration personnalisée de la toile (polyester et acrylique) pour adapter votre marque et votre image d'entreprise à 100 % grâce à différentes solutions de marquage.

APPLICATIONS APPLICATIONS



Hotel
Hôtel



Restaurant
Restaurant



Bar
Bar



Café
Café

ACCESSORIES

ACCESSOIRES

Add functionality and character to your spaces with our most innovative accessories. Create unique environments with solutions that reflect your style and enhance the outdoor experience.

Ajoutez fonctionnalité et caractère à vos espaces avec nos accessoires les plus innovants. Créez des environnements uniques grâce à des solutions qui reflètent votre style et subliment l'expérience en plein air.

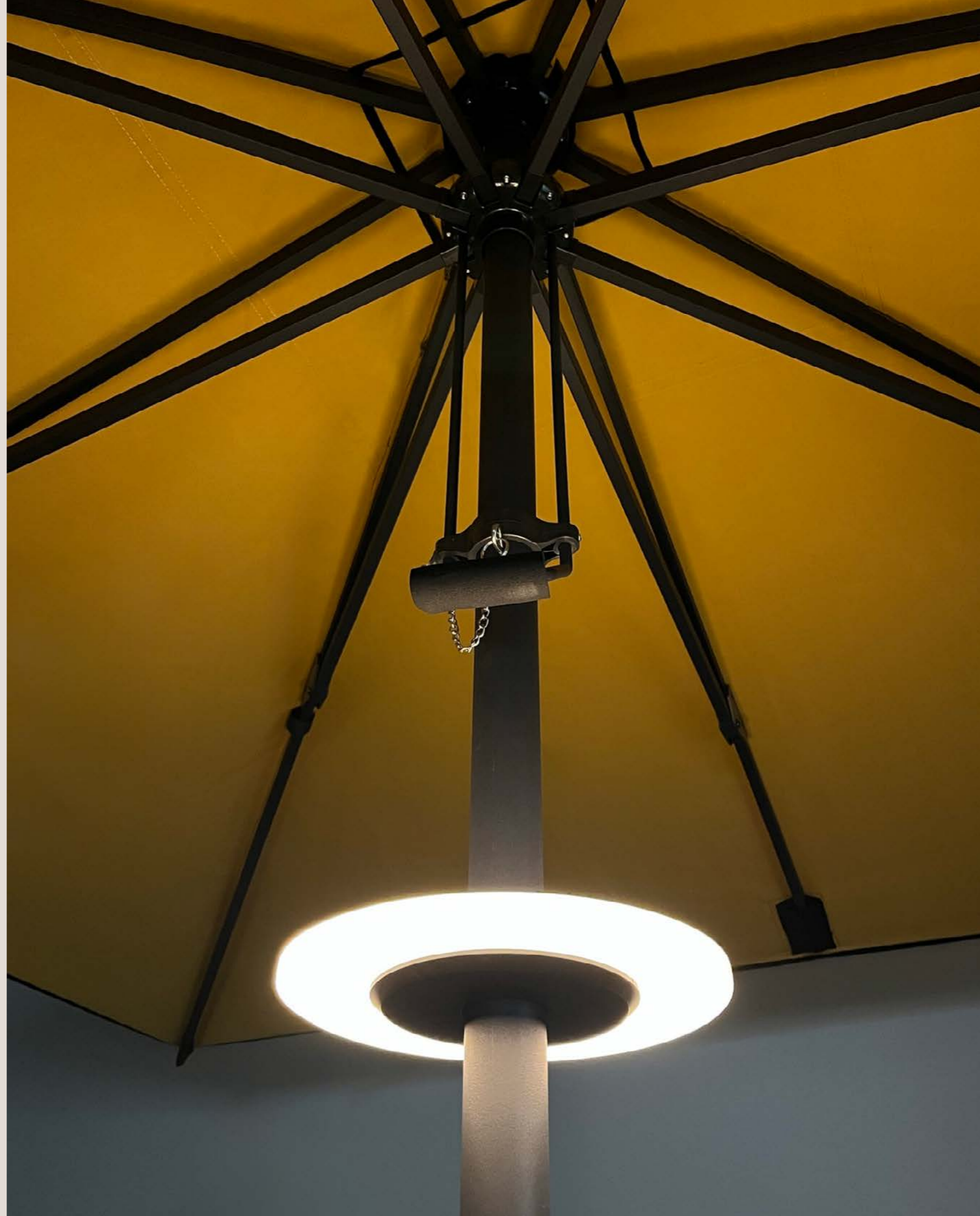

UFO LIGHT

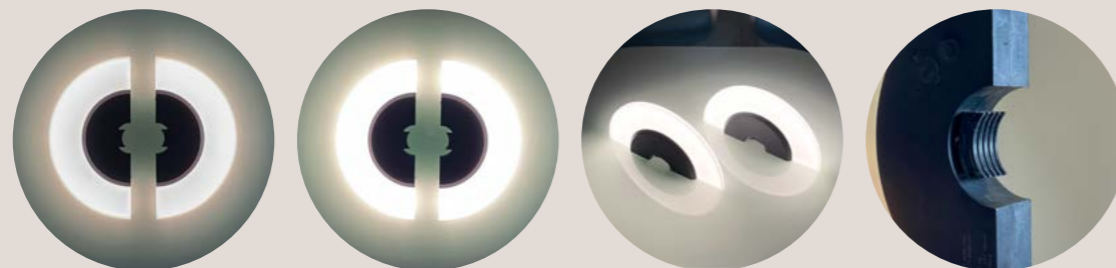

Product Produit	2-in-1 magnetic LED light Lampe LED magnétique 2 en 1
Integrated rechargeable battery Batterie rechargeable intégrée	3.7V/2500 MAH
Battery type Type de batterie	Lithium battery Batterie au lithium
Battery capacity Capacité de la batterie	2500 MAH
Dim mode Mode tamisé	20 LM
Battery life (20 LM) Autonomie (20 LM)	Approx. 20 h Environ 20 h
Super bright mode Mode super lumineux	130 LM
Battery life (130 LM) Autonomie (130 LM)	Approx. 6 h Environ 6 h
Charging time Temps de charge	Over 5 h Plus de 5 h
Charging voltage Tension de charge	DC 5V/1A
Maximum compatible size of the parasol mast Dimensions maximales compatibles du mât du parasol	Round post Ø48 mm or square post 38×38 mm Mât rond Ø48 mm ou mât carré 38×38 mm
Minimum compatible size of the parasol mast Dimensions minimales compatibles du mât du parasol	Round post Ø35 mm or square post 38×38 mm Mât rond Ø35 mm ou mât carré 38×38 mm

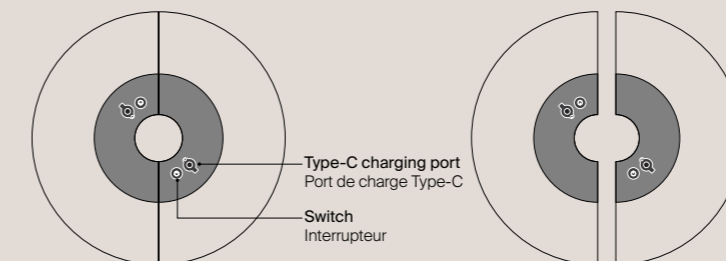

BASES BASES

	INTERMEDIATE CANES (1) CANNES INTER-MEDIAIRES (1)		SURFACE-MOUNTED EN SURFACE					
	EXTERNAL EXTERNE	PLATE ANCHORED TO THE GROUND PLAQUE ANCRÉE AU SOL	CROSS BASE WITH 4-STONE KIT CROIX AVEC KIT 4 DALLES	MOBILE BASES WITH WHEELS BASES MOBILES AVEC ROUES				
CALPE	-	-	BASE CALPE*	BM-100 ****	-	-	-	-
PISA	-	-	BASE PISA*	-	-	-	-	-
SINTRA	-	-	BASE SINTRA*	BM-100 ****	-	-	-	-
ARLES	105-1/IB	S/95-IB	BC/160 D	-	BM/60-IB ■	BM-50	BM-48	BM-40
ANTIBES	-	-	-	-	-	-	-	-
TAVIRA	-	-	-	-	-	-	BM-48	BM-40
RAYDEN	105-1/IB	S/95-IB	BC/160/D	-	BM/60-IB ■	BM-50	BM-48	-
STAR-ONE	105-1/IB	S/95-IB	-	-	BM/60-IB ■	BM-50	BM-48	BM-40
STAR-LIT	-	-	-	-	-	BM-50	-	BM-40

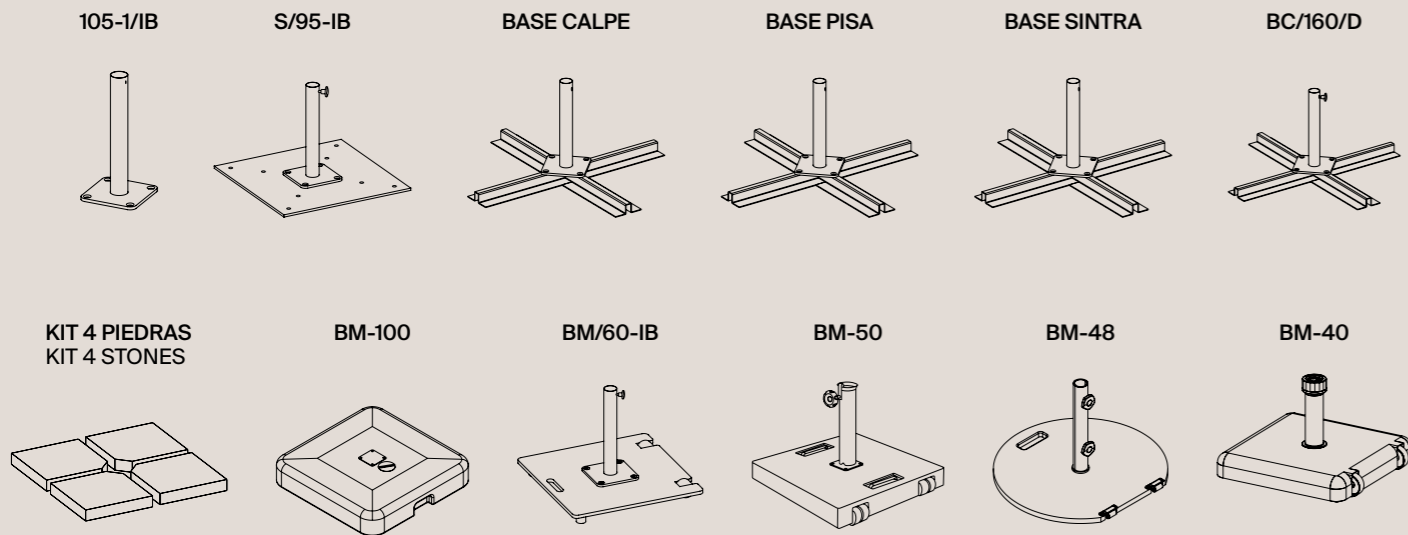

* Cross base included with the parasol; the 4-Stone Kit must be added
Croix incluse avec le parasol ; il est nécessaire d'ajouter le kit 4 dalles
1-50-489-000134

** Star-Lit and Novara with B-40 and B-35 bases require an additional adaptor
Star-Lit et Novara avec bases B-40 et B-35 : ajout d'un adaptateur nécessaire
1-50-050-000167



*** Star-Lit and Novara with BM-50, BS-43 and B-17 bases require additional Ø50, Ø38 and Ø32 mm adaptors
Star-Lit et Novara avec bases BM-50, BS-43 et B-17 ajout d'adaptateurs Ø50, Ø38 et Ø32 mm nécessaire
1-50-050-000171



See instruction sheet
Voir la fiche d'instructions

**** The intermediate pole is supplied with the Calpe and Sintra parasols
La canne intermédiaire est fournie avec les parasols Calpe et Sintra

SURFACE-MOUNTED EN SURFACE							PLATE PLAQUE	
MOBILE BASES WITH WHEELS BASES MOBILES AVEC ROUES								
-	-	-	-	-	-	-	-	-
-	-	-	-	-	-	-	-	-
-	-	-	-	-	-	-	-	-
BM-35	BM-36 ■	-	B-40 ■	B-35 ■	-	BS-43 ◆	-	BS-19 ▲
-	-	-	-	-	BS-22	-	-	-
BM-35	BM-36 ■	BM-25	B-40 ■	B-35 ■	-	BS-43 ◆	B-17 ✱	BS-19 ▲
-	-	-	-	-	-	BS-43 ◆	-	-
BM-35	BM-36 ■	-	B-40 ■	B-35 ■	-	BS-43 ◆	B-17 ✱	BS-19 ▲
BM-35	-	BM-25	-	B-35** ■	-	BS-43*** ◆	B-17 ***	BS-19 ▲

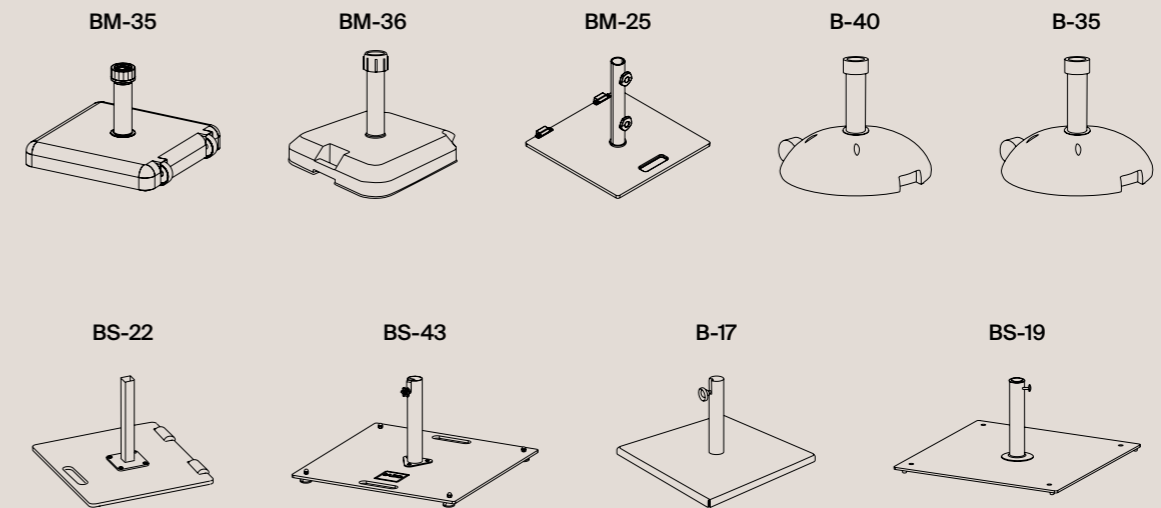

Maximum parasol dimensions to ensure Beaufort scale wind resistance grade 4:
Dimensions maximales du parasol pour garantir une résistance au vent de classe 4 sur l'échelle de Beaufort:

◆ Max. Ø3, 3x3 y 3x2,5

■ Max. Ø3, 2,5x2,5 y 3x2

▲ Max. 2,5x2,5

✱ Max. 2,0x2,0

PROTECTIVE COVER

HOUSSE DE PROTECTION



	Offset mast Mât excentré		Centered mast Mât centré						
	Calpe	Pisa	Sintra	Arles	Antibes	Tavira	Rayden	Star One	Star Lit
Cover S Housse S <small>(from 02.5 to 2,2x2,2 m) (des 02.5 à 2,2x2,2 m)</small>					•	•			
Cover M Housse M <small>(from 2,5x2,5 to 3x3 m) (des 02.5 à 2,2x2,2 m)</small>				•			•	•	•
Cover L Housse L <small>(4x4 m)</small>			•						
Cover EX Housse EX <small>(3x3 m)</small>	•	•							

FABRICS

TISSUS



BEIGE OLEFIN
OLÉFINE BEIGE

Grammage 220 g/m²

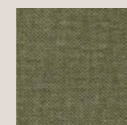

DARK GREEN OLEFIN
OLÉFINE VERT FONCÉ

Grammage 220 g/m²



TERRACOTA OLEFIN
OLÉFINE TERRACOTA

Grammage 220 g/m²



WHITE OLEFIN
OLÉFINE BLANC

Grammage 220 g/m²

IASO[®]

Better Outside

© 2026 IASO. All rights reserved.

We believe in the *elegance* of engineering.