

IASO®

Better Outside

CATÁLOGO
CATÁLOGO

ESPAÑOL
PORTUGUÊS

PARASOLES
GUARDA-SÓIS

SMALL COLLECTION
2025



We bring people together.
Pioneering shades as spaces meant to be lived.
Spaces to breathe, rest, connect, and celebrate.
Our products are made for a joyful living.
Every step is guided by a pursuit of excellence and
exceptional attention to detail is at the heart of everything we do.
We transform open spaces into places where life happens,
spaces where people build their memories, where stories are born.
Because we believe life is

Better Outside

CUATRO DÉCADAS DE EXCELENCIA

40 years of outstanding
sun shading



En 1984 comenzamos un viaje en el mundo de la protección solar. Tol-dos, parasoles y pérgolas marcaron nuestro origen, consolidándonos rápidamente como una de las marcas más emblemáticas de la península ibérica.

A lo largo de los años, nuestra visión nos ha llevado a especializarnos en soluciones textiles para exteriores, ampliando nuestras líneas de negocio con Piscinas y Arquitectura Textil. Este enfoque nos permitió traspasar fronteras, llevando nuestras creaciones a más de 36 países.

En 2024 celebramos 40 años transformando espacios al aire libre en lugares donde las historias cobran vida, reafirmandonos como referentes internacionales en protección solar textil.

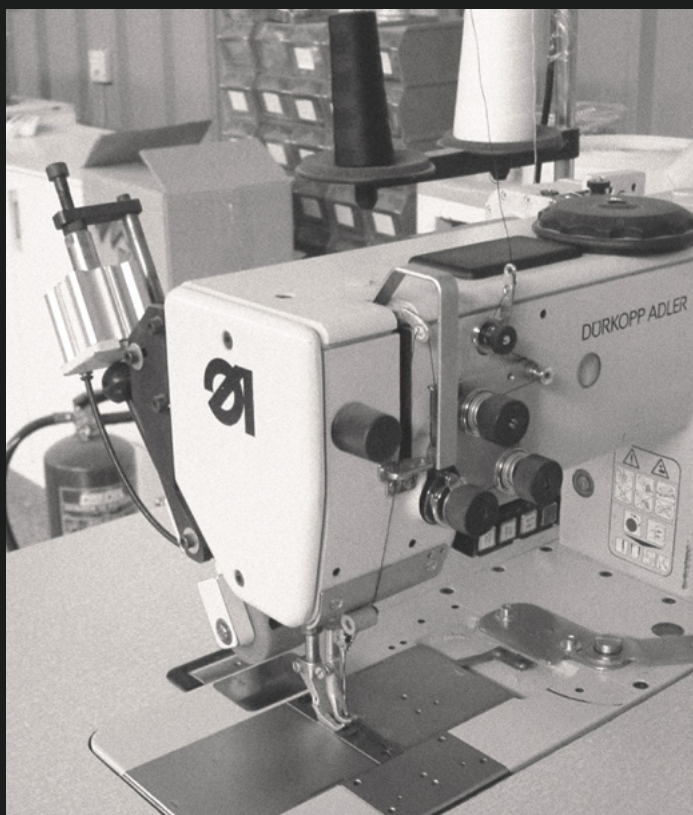

Em 1984, iniciamos uma jornada no mundo da proteção solar. Toldos, guarda-sóis e pérgolas marcaram o nosso início, consolidámo-nos rapidamente como uma das marcas mais emblemáticas da Península Ibérica.

Ao longo dos anos, a nossa visão levou-nos a especializar em soluções têxteis para exteriores, ampliando a nossa área de atuação com Piscinas e Arquitetura Têxtil. Este foco permitiu-nos ultrapassar fronteiras, levando as nossas criações a mais de 36 países.

Em 2024, celebrámos 40 anos a transformar espaços ao ar livre em cenários onde as histórias ganham vida, reafirmando-nos como referência internacional em proteção solar têxtil.

*QUATRO
DÉCADAS DE
EXCELÊNCIA*

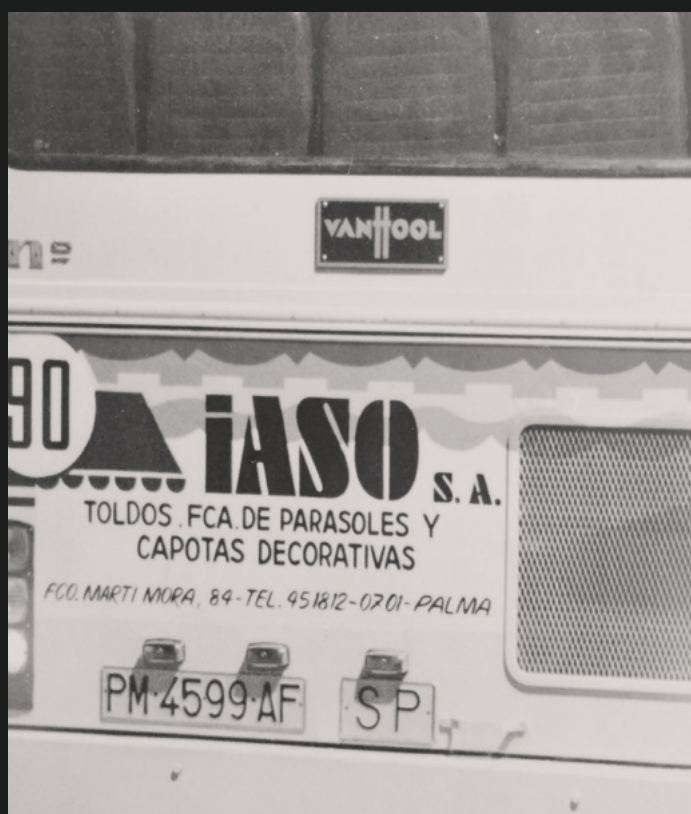

NUESTRA IDENTIDAD

En IASO, evolucionar significa cuidar de cada detalle, trascendiendo lo funcional para crear experiencias que inspiran. Hoy, guiados por nuestros valores fundamentales, seguimos mirando al futuro con un compromiso inquebrantable de innovar y conectar.

ELEGANCIA E INGENIERÍA

En IASO, la ingeniería se convierte en arte. Cada diseño está pensado para encontrar la armonía perfecta entre la funcionalidad impecable y una estética que inspira. Con líneas depuradas y detalles precisos, nuestras soluciones trascienden el tiempo, creando espacios que son tan impactantes como útiles.

CALIDAD E INNOVACIÓN

Para nosotros, la excelencia no es un destino, sino un camino constante. Desde nuestro equipo de I+D+R, imaginamos nuevas formas de dar vida a productos que combinan la eficiencia técnica con soluciones visionarias.

CONEXIÓN HUMANA

Creemos en el poder de los espacios para unir a las personas. Cada uno de nuestros proyectos está diseñado para generar emociones, invitando a compartir momentos únicos. Nuestro compromiso comienza con el primer contacto y continúa mucho después, acompañando a nuestros clientes en cada etapa con un enfoque cercano y cuidado.





O NOSSA IDENTIDADE

Na IASO, evoluir significa cuidar de cada detalhe, transcendendo o funcional para criar experiências que inspiram. Hoje, guiados por nossos valores fundamentais, continuamos a olhar para o futuro com o compromisso inabalável de inovar e conectar.

ELEGÂNCIA E ENGENHARIA

Na IASO, a engenharia transforma-se em arte. Cada design é concebido para encontrar a harmonia perfeita entre funcionalidade impecável e uma estética inspiradora. Com linhas depuradas e detalhes precisos, nossas soluções transcendem o tempo, criando espaços que são tão impactantes quanto úteis.

QUALIDADE E INOVAÇÃO

Para nós, a excelência não é um destino, mas um caminho constante. A partir de nossa equipe de I+D+R, imaginamos novas formas de dar vida a produtos que combinam eficiência e técnica com soluções visionárias.

CONEXÃO HUMANA

Acreditamos no poder dos espaços para unir pessoas. Cada um de nossos projetos é projetado para gerar emoções, convidando a compartilhar momentos únicos. O nosso compromisso começa no primeiro contato e estende-se muito além, acompanhando os nossos clientes em cada etapa com um foco próximo e cuidado.

SMALL COLLECTION	—	11
		15
		19
		23
		27
		31
		35
		39
		43
		47





Ligereza y
practicidad
para
espacios
exclusivos

*Leveza e
praticidade
para espaços
exclusivos*

TAVIRA

CONFIGURACIÓN

CONFIGURAÇÃO

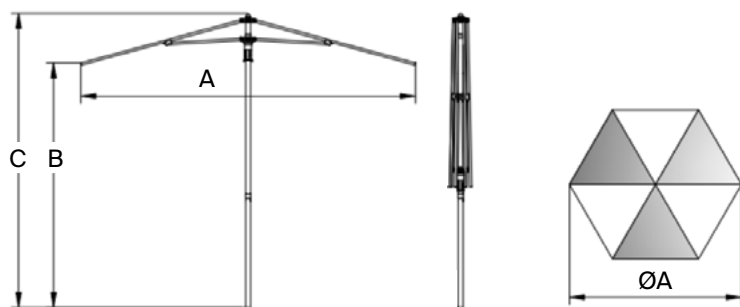

Medidas Medidas A (m)	Altura libre Altura livre B (cm)	Altura abierto Altura aberto C (cm)	Mástil redondo* Mastro redondo* (mm)	Varillas Varetas (mm)	Nº Varillas Nº de Varetas
Ø2,5	195	233	Ø38,4	Ø19	6

*Mástil centrado

*Mastro central

DETALLES DETALHES



COLOR DE MÁSTIL COR DO MASTRO

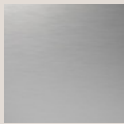

Anodizado mate
Anodizado fosco

COLOR DEL TEJIDO COR DO TECIDO



Olefina beige
Olefina bege

COMPATIBILIDAD COMPATIBILIDADE

- **UFO LIGHT**
UFO LIGHT
(p. 44)
- **Base recomendada**
Base recomendada
Modelo BS-19 (p. 46)
- **Funda protectora**
Capa protetora
(p. 47)

APLICACIONES APLICAÇÕES



Particular
Particular



Hotel
Hotel



Resort
Resort



Diseño
compacto y
funcional

*Design
compacto e
funcional*

ANTIBES



CONFIGURACIÓN

CONFIGURAÇÃO

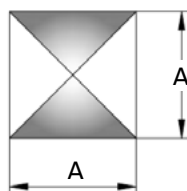
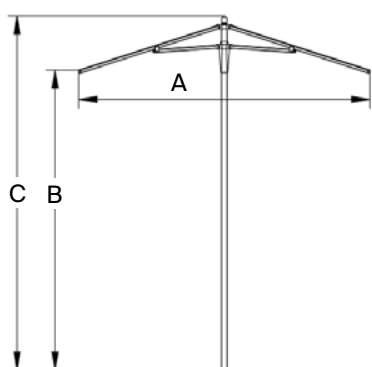

Medidas Medidas A (m)	Altura libre Altura livre B (cm)	Altura abierto Altura aberto C (cm)	Mástil cuadrado* Mastro quadrado* (mm)	Varillas Varetas (mm)	Nº Varillas Nº de Varetas
2,2x2,2	195	235	38x38	22x22	4

*Mástil en 2 piezas centrado

*Mastro em 2 peças central

DETALLES DETALHES



COLOR DE MÁSTIL COR DO MASTRO



Negro
Preto

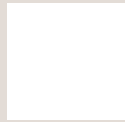

Blanco
Branco

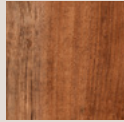

Efecto madera
Efeito madeira

COLOR DEL TEJIDO COR DO TECIDO



Olefina beige
Olefina bege

ACCESORIOS INCLUIDOS ACESSÓRIOS INCLUÍDOS

- **Base Antibes**
Base Antibes
(p. 46)

COMPATIBILIDAD COMPATIBILIDADE

- **UFO LIGHT**
UFO LIGHT
(p. 44)
- **Funda protectora**
Capa protetora
(p. 47)

APLICACIONES APLICAÇÕES



Particular
Particular



Hotel
Hotel



Resort
Resort



Elegancia,
versatilidad
y resistencia

*Elegância,
versatilidade
e resistência*

ARLES

CONFIGURACIÓN

CONFIGURAÇÃO

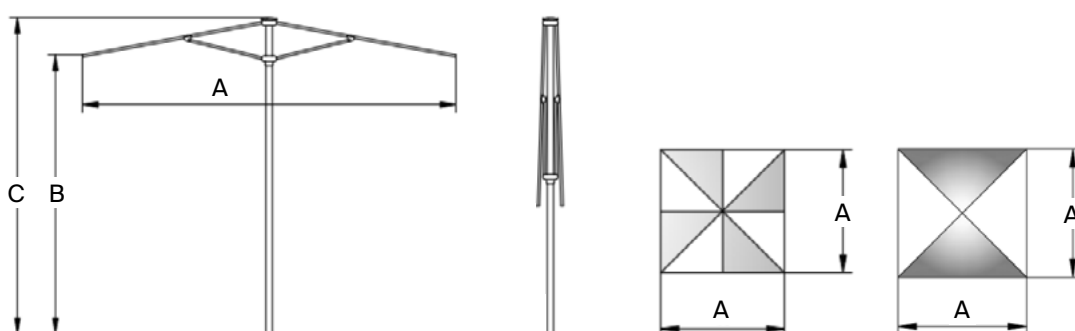

Dimensiones Dimensões	Altura libre Altura livre	Altura abierto Altura aberto	Mástil cuadrado* Mastro quadrado*	Varillas Varetas	N.º de varillas N.º de varetas
A (m)	B (cm)	C (cm)	(mm)	(mm)	
2,5x2,5	220	263	Ø48	16x28	4
3x3	220	263	Ø48	16x28	8

*Mástil centrado de dos piezas

*Mastro central em duas peças

DETALLES DETALHES

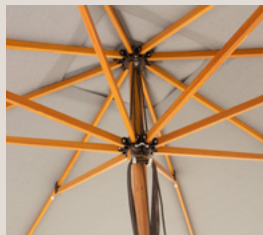

COLOR DE MÁSTIL COR DO MASTRO

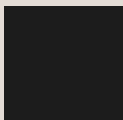

Negro
Preto

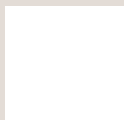

Blanco
Branco

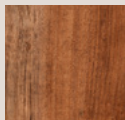

Efecto
madera
Efeito
madeira

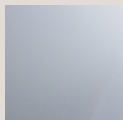

Anodizado
espejo
Anodizado
espelhado

COLOR DEL TEJIDO COR DO TECIDO



Olefina
beige
Olefina
bege

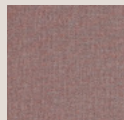

Olefina
terracota
Olefina
terracota

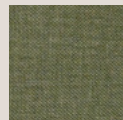

Olefina verde
oscuro
Olefina verde
escuro

COMPATIBILIDAD COMPATIBILIDADE

- **UFO LIGHT**
UFO LIGHT
(p. 44)
- **Base recomendada**
Base recomendada
Modelo BM-40 (p. 46)
- **Funda protectora**
Capa protetora
(p. 47)

APLICACIONES APLICAÇÕES



Particular
Particular



Hotel
Hotel



Resort
Resort



Restaurante
Restaurante



Bar
Bar



Cafeteria
Cafeteria





Diseño
práctico y
precisión
total

*Design
práctico e
precisão
total*

PISA

CONFIGURACIÓN

CONFIGURAÇÃO

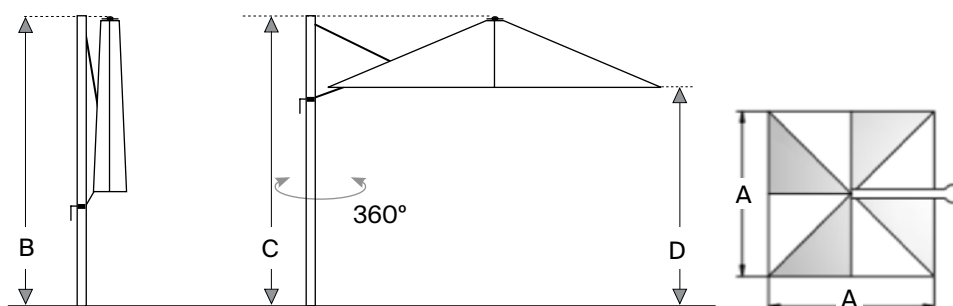

Dimensiones Dimensões	Altura total Altura total	Altura del mástil Altura do mastro	Altura libre Altura livre	Base Base (kg)	Mástil cuadrado* Mastro quadrado*	Varillas Varetas (mm)	N.º de varillas N.º de varetas
A (m)	B (cm)	C (cm)	D (cm)		C (cm)		

3x3	270	270	210	70	95x65	17x25	8
-----	-----	-----	-----	----	-------	-------	---

*Mástil excéntrico

*Mastro excêntrico

DETALLES DETALHES



FUNCIÓN FUNÇÃO

- **Basculación izquierda y derecha**
Inclinação para a esquerda e direita
- **Inclinación hacia arriba y abajo**
Inclinação para cima e para baixo
- **Rotación 360°**
Rotação 360°

COLOR DE MÁSTIL COR DO MASTRO

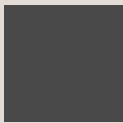

Antracita
Antracite

COLOR DEL TEJIDO COR DO TECIDO

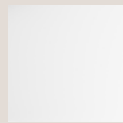

Poliéster blanco
Poliéster branco

ACCESORIOS ACESSÓRIOS



Base cruceta
Base cruzeta

COMPATIBILIDAD COMPATIBILIDADE

- **UFO LIGHT**
UFO LIGHT
(p. 44)
- **Kit de 4 piedras**
Kit de 4 pedras
(p. 47)
- **Funda protectora**
Capa protetora
(p. 47)

APLICACIONES APLICAÇÕES



Particular
Particular



Hotel
Hotel



Resort
Resort



Restaurante
Restaurante



Bar
Bar



Cafeteria
Cafeteria



Iluminación
elegante
para todo
momento

*Iluminação
elegante
para todos os
momentos*

CALPE

CONFIGURACIÓN

CONFIGURAÇÃO

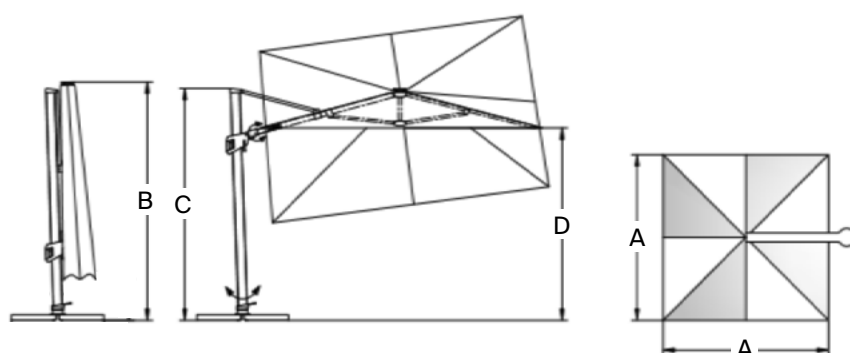

Dimensiones Dimensões	Altura total Altura total	Altura del mástil Altura do mastro	Altura libre Altura livre	Base Base	Mástil cuadrado* Mastro quadrado*	Varillas Varetas	N.º de varillas N.º de varetas
A (m)	B (cm)	C (cm)	D (cm)	(kg)	C (cm)	(mm)	

3x3	252	255	215	100	75x100	16x28	8
-----	-----	-----	-----	-----	--------	-------	---

*Mástil descentrado

*Mastro excêntrico

DETALLES DETALHES



FUNCIÓN FUNÇÃO

- **Basculación izquierda y derecha**
Inclinação para a esquerda e direita
- **Inclinación hacia arriba y abajo**
Inclinação para cima e para baixo
- **Rotación de 360°**
Rotação de 360°

COLOR DE MÁSTIL COR DO MASTRO

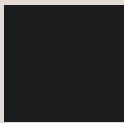

Negro
Preto

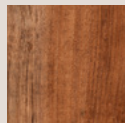

Efecto madera
Efeito madeira

COLOR DEL TEJIDO COR DO TECIDO



Olefina
beige
Olefina
bege



Olefina
terracota
Olefina
terracota



Olefina
verde oscuro
Olefina
verde oscuro

ACCESORIOS ACESSÓRIOS



Luces LED
con panel solar
Luzes LED
com painel solar



Base cruceta
Base cruzeta

COMPATIBILIDAD COMPATIBILIDADE

- **Kit de 4 piedras**
Kit de 4 pedras
(p. 47)
- **Funda protectora**
Capa protetora
(p. 47)

APLICACIONES APLICAÇÕES



Particular
Particular



Hotel
Hotel



Resort
Resort



Restaurante
Restaurante



Bar
Bar



Cafeteria
Cafeteria





Iluminación
sofisticada y
protección
completa

*Iluminação
sofisticada
e proteção
completa*

SINTRA

CONFIGURACIÓN

CONFIGURAÇÃO

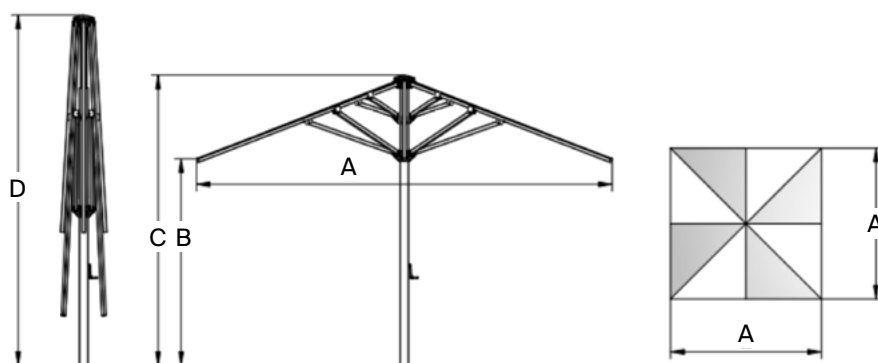

Dimensiones Dimensões	Altura libre Altura livre	Altura abierto Altura aberto	Altura total Altura total	Mástil redondo* Mastro redondo*	Varillas Varetas	N.º de varillas N.º de varetas
A (m)	D (cm)	C (cm)	B (cm)	C (cm)	(mm)	

4x4	225	239	362	Ø100	20x30	8
-----	-----	-----	-----	------	-------	---

*Mástil centrado

*Mastro central

DETALLES DETALHES

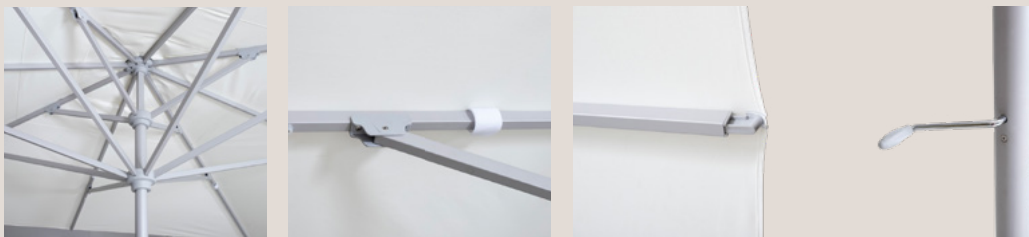

COLOR DE MÁSTIL COR DO MASTRO

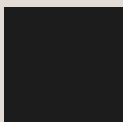

Negro
Preto

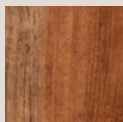

Efecto madera
Efeito madeira

COLOR DEL TEJIDO COR DO TECIDO



Olefina
beige
Olefina
bege

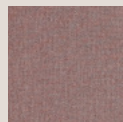

Olefina
terracota
Olefina
terracota

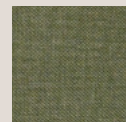

Olefina verde
oscuro
Olefina verde
escuro

ACCESORIOS ACESSÓRIOS



Luces LED
con panel solar
Luzes LED
com painel solar



Base cruzeta
Base cruzeta

COMPATIBILIDAD COMPATIBILIDADE

- Kit de 4 piedras
Kit de 4 pedras
(p. 47)
- Funda protectora
Capa protetora
(p. 47)

APLICACIONES APLICAÇÕES



Particular
Particular



Hotel
Hotel



Resort
Resort



Restaurante
Restaurante



Bar
Bar



Cafeteria
Cafeteria



Sencillez,
comodidad
y ergonomía

*Simplicidade,
conforto
e ergonomia*

RAYDEN

CONFIGURACIÓN

CONFIGURAÇÃO

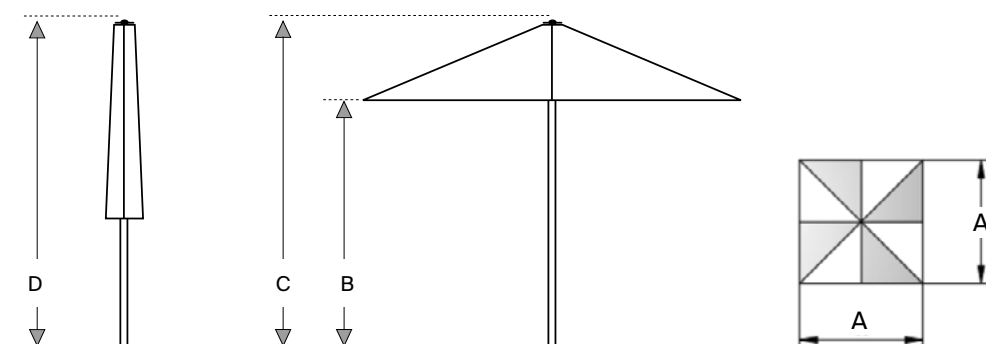

Dimensiones Dimensões	Altura libre Altura livre	Altura desplegado Hauteur ouverte	Altura abierto Hauteur totale	Mástil redondo* Mastro redondo*	Varillas Varetas	N.º de varillas N.º de varetas
A (m)	D (cm)	C (cm)	B (cm)	C (cm)	(mm)	

3x3	220	278	278	Ø50	18x28	8
-----	-----	-----	-----	-----	-------	---

*Mástil central
*Mastro central

DETALLES DETALHES



COLOR DEL TEJIDO COR DO TECIDO



La lona del parasol Rayden es completamente personalizable. Descubre toda nuestra gama de colores (poliéster y acrílico) con nuestros expertos.

A lona do guarda-sol Rayden é totalmente personalizável. Descubra toda a nossa gama de cores (poliéster e acrílico) com os nossos especialistas.

COMPATIBILIDAD COMPATIBILIDADE

- Compatible con una gran variedad de bases.
Consulta tu solución ideal con nuestros expertos.
Compatível com uma grande variedade de bases.
Consulte a solução ideal com os nossos especialistas.

PERSONALIZACIÓN PERSONALIZAÇÃO

Rayden permite una configuración personalizada de la lona para adaptar tu marca e imagen corporativa al 100% mediante distintas soluciones de rotulación.

O Rayden permite uma configuração personalizada da lona para adaptar a sua marca e imagem corporativa a 100% através de diferentes soluções de rotulagem.

APLICACIONES APLICAÇÕES



Hotel
Hotel



Restaurante
Restaurante



Bar
Bar



Cafeteria
Cafeteria



Resistencia,
robustez y
versatilidad

*Resistência,
robustez e
versatilidade*

STAR ONE



CONFIGURACIÓN

CONFIGURAÇÃO

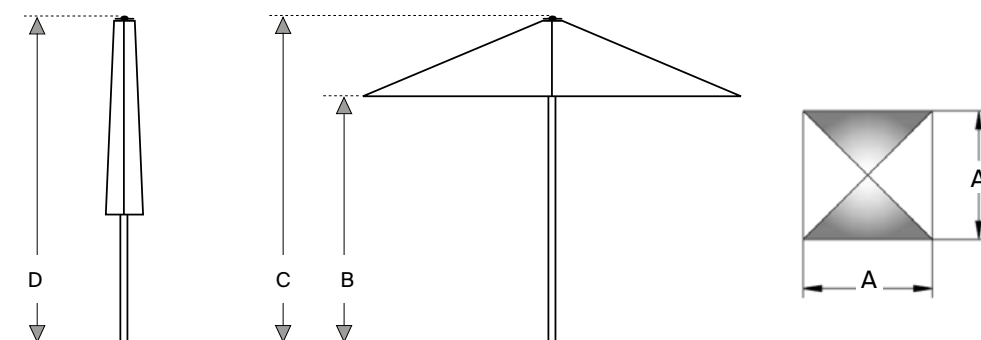

Dimensiones Dimensões	Altura libre Altura total	Altura total Altura do mastro	Mástil redondo* Mastro redondo*	Varillas Varetas (mm)	N.º de varillas N.º de varetas
A (m)	D (cm)	B (cm)	C (cm)		
2x2	226	260	Ø50	20x30	4
2,5x2,5	220	260	Ø50	20x30	4

*Mástil centrado

*Mastro central

DETALLES DETALHES

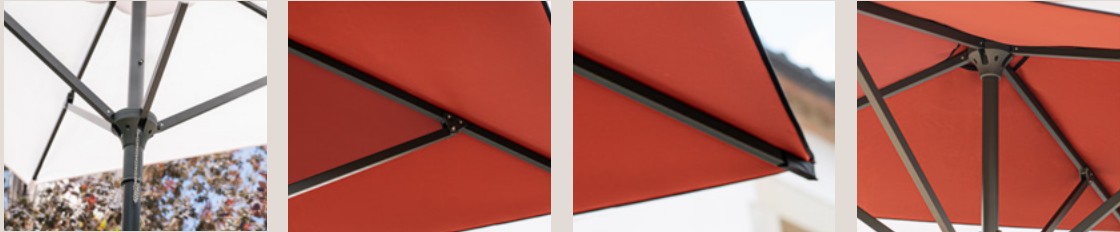

COLOR DE MÁSTIL COR DO MASTRO



RAL 7026

COLOR DEL TEJIDO COR DO TECIDO



Descubre toda nuestra gama de lonas con nuestros expertos.

Descubra toda a nossa gama de lonas com os nossos especialistas.

COMPATIBILIDAD COMPATIBILIDADE

- Compatible con una gran variedad de bases.
Consulta tu solución ideal con nuestros expertos.
Compatível com uma grande variedade de bases.
Consulte a solução ideal com os nossos especialistas.

PERSONALIZACIÓN PERSONALIZAÇÃO

Star One permite una configuración personalizada de la lona (poliéster y acrílico) para adaptar tu marca e imagen corporativa al 100% mediante distintas soluciones de rotulación.

O Star One permite uma configuração personalizada da lona (poliéster e acrílico) para adaptar a sua marca e imagem corporativa a 100% através de diferentes soluções de rotulagem.

APLICACIONES APLICAÇÕES



Hotel
Hotel



Restaurante
Restaurante



Bar
Bar



Cafeteria
Cafetaria



El Celler

El Celler

El Celler

El Celler

El Celler

WHEAT
BOTTLE
DISTRIBUTION

Minimalismo
y protección
con estilo

*Minimalismo
e proteção
com estilo*

STAR LIT

CONFIGURACIÓN

CONFIGURAÇÃO

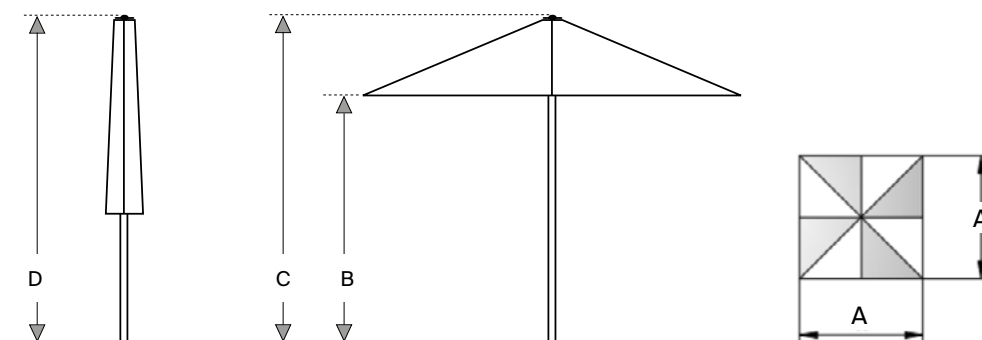

Dimensiones Dimensões	Altura libre Altura livre	Altura abierto Altura aberto	Altura total Altura total	Mástil redondo* Mastro redondo*	Varillas Varetas	N.º de varillas N.º de varetas
A (m)	D (cm)	C (cm)	B (cm)	C (cm)	(mm)	

2,5x2,5	220	258	258	Ø38	18x12	4
---------	-----	-----	-----	-----	-------	---

*Mástil centrado

*Mastro central

DETALLES DETALHES

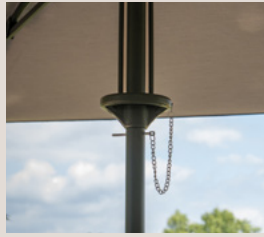

COLOR DE MÁSTIL COR DO MASTRO



RAL 7026

COLOR DEL TEJIDO COR DO TECIDO



Descubre toda nuestra gama de lonas con nuestros expertos.

Descubra toda a nossa gama de lonas com os nossos especialistas.

COMPATIBILIDAD COMPATIBILIDADE

- Compatible con una gran variedad de bases.
Consulta tu solución ideal con nuestros expertos.
Compatível com uma grande variedade de bases.
Consulte a solução ideal com os nossos especialistas.

- UFO LIGHT
UFO LIGHT
(p. 44)

PERSONALIZACIÓN PERSONALIZAÇÃO

Star Lit permite una configuración personalizada de la lona (poliéster y acrílico) para adaptar tu marca e imagen corporativa al 100% mediante distintas soluciones de rotulación.

O Star Lit permite uma configuração personalizada da lona (poliéster e acrílico) para adaptar a sua marca e imagem corporativa a 100% através de diferentes soluções de rotulagem.

APLICACIONES APLICAÇÕES



Hotel
Hotel



Restaurante
Restaurante



Bar
Bar



Cafeteria
Cafeteria



ACCESORIOS *ACESSÓRIOS*

UFO LIGHT

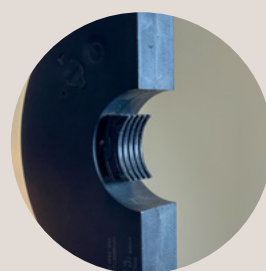
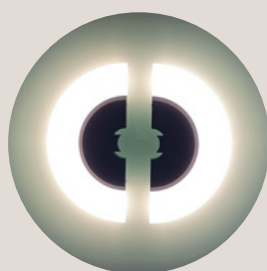
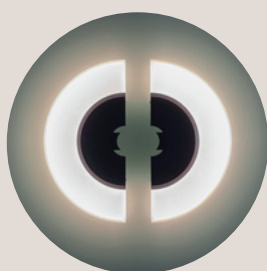

Producto Produto	Luz LED magnética 2 en 1 Luz LED magnética 2 em 1
Batería recargable integrada Bateria recarregável integrada	3.7V/2500 MAH
Tipo de batería Tipo de bateria	Batería de litio Bateria de lítio
Capacidad de la batería Capacidade da bateria	2500 MAH
Modo tenue Modo suave	20 LM
Duración de la batería (20 LM) Duração da bateria (20 LM)	20 h aprox.
Modo super brillante Modo superbrilhante	130 LM
Duración de la batería (130 LM) Duração da bateria (130 LM)	6 h aprox.
Tiempo de carga Tempo de carga	Más de 5 h Mais de 5 h
Voltaje de carga Voltagem de carga	DC 5V/1A
Máxima medida compatible del mastil del parasol Medida máxima compatível do mastro do guarda-sol	Poste redondo de Ø48 mm o poste cuadrado de 38×38 mm Poste redondo de Ø48 mm ou poste quadrado de 38×38 mm
Minimum compatible size of parasol mast Dimensions minimales compatibles du mât du parasol	Poste redondo de Ø35 mm o poste cuadrado de 38×38 mm Poste redondo de Ø35 mm ou poste quadrado de 38×38 mm

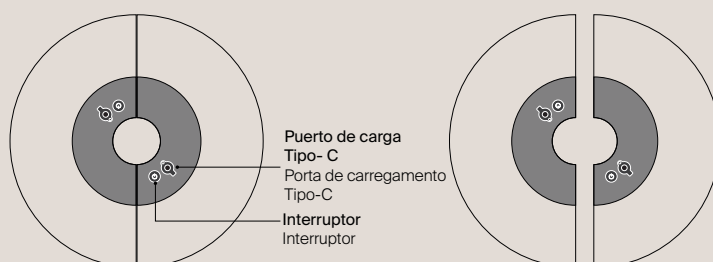

BASES

BASES

Resistencia al viento 
Resistência ao vento

BM-40

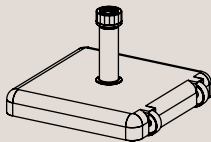

- **Peso: 40 Kg**
Peso: 40 kg
- **Color: negro**
Cor: preto
- **Mástil compatible:**
de Ø38 a Ø50 mm
Mastro compatível:
de Ø38 a Ø50 mm

Velocidad máxima soportada hasta 28 Km/h, en medidas de hasta Ø2,5 m o 2,5×2,5 m.

Velocidade máxima suportada até 28 km/h, em medidas de até Ø2,5 m ou 2,5×2,5 m.

BM-25

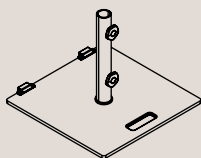

- **Peso: 25 Kg**
Peso: 25 kg
- **Color: negro o blanco**
Cor: preto ou branco
- **Parasol Tavira**
Guarda-sol Tavira

Velocidad máxima soportada hasta 19 Km/h, en medidas de hasta Ø2,5 m o 2,5×2,5 m.

Velocidade máxima suportada até 19 km/h, em medidas de até Ø2,5 m ou 2,5×2,5 m.

BASE ANTIBES

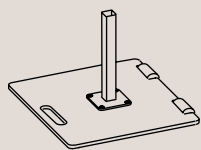

- **Peso: 22 Kg**
Peso: 22 kg
- **Color: negro o blanco**
Cor: preto ou branco
- **Parasol Antibes**
Guarda-sol Antibes

Velocidad máxima soportada hasta 19 Km/h, en medidas de hasta 2,2×2,2 m.

Velocidade máxima suportada até 19 km/h, em medidas de até 2,2×2,2 m.

BM-100

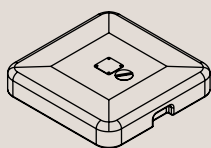

- **Peso: 108 Kg (rellena con agua)**
108 Kg (rellena con arena)
Peso: 108 kg (cheia com água)
108kg (cheia com areia)
- **Color: negro**
Cor: preto
- **Parasol Sintra y Calpe**
Guarda-sóis Sintra y Calpe

Con agua:

Velocidad máxima soportada hasta 19 Km/h, en medidas de hasta 4×4 m.

Com água:

Velocidade máxima suportada até 19 km/h, em medidas de até 4×4 m.

Con arena:

Velocidad máxima soportada hasta 28 Km/h, en medidas de hasta 4×4 m.

Com areia:

Velocidade máxima suportada até 28 km/h, em medidas de até 4×4 m.

BS-19

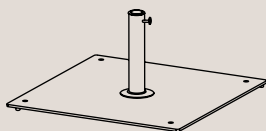

- **Peso: 19 Kg**
Peso: 19 kg
- **Color: negro o blanco**
Cor: preto ou branco
- **Mástil compatible: Ø38, Ø48 y Ø50 mm**
Mastro compatível: Ø38, Ø48 e Ø50 mm

Velocidad máxima soportada hasta 19 Km/h, en medidas de hasta 2,5×2,5 m.

Velocidad máxima soportada hasta 11 Km/h, en medidas de hasta 3×3 m.

Velocidade máxima suportada até 19 km/h, em medidas de até 2,5×2,5 m.
Velocidade máxima suportada até 11 km/h, em medidas de até 3×3 m.

IASO[®]

Better Outside

© 2025 IASO. All rights reserved.

We believe in the *elegance* of engineering.